

# NCS1010 SIDE BENDING

Flexible Silicone LED Neon Strip

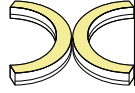

# SPECIFICATION



CE RoHS

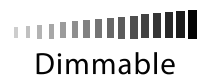

Dimmable

## Custom LED Linear Lighting System Solutions.

We deliver complete LED linear lighting systems — designed for architectural and commercial projects that require stable performance, system compatibility, and project-specific customization.

With OEM customization, branded details, and exclusive product development, we help transform lighting from a functional element into a refined expression of brand character and experience.

# NCS1010 SIDE BENDING

Flexible Silicone LED Neon Strip

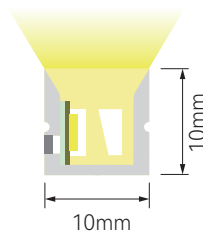
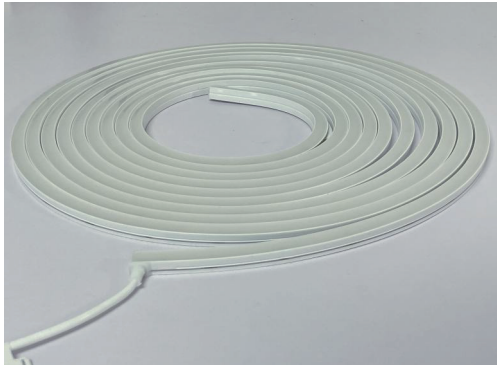

Across section size's picture

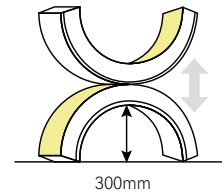

Three color silicone structure with clear cutting mark.

Bendable at vertical direction.

High lumen solution with special structure

High light transmittance, environmental silicone material.

Unique optical light distribution structural design, uniform lighting.

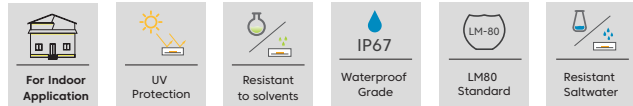

## DIMENSION STRUCTURE

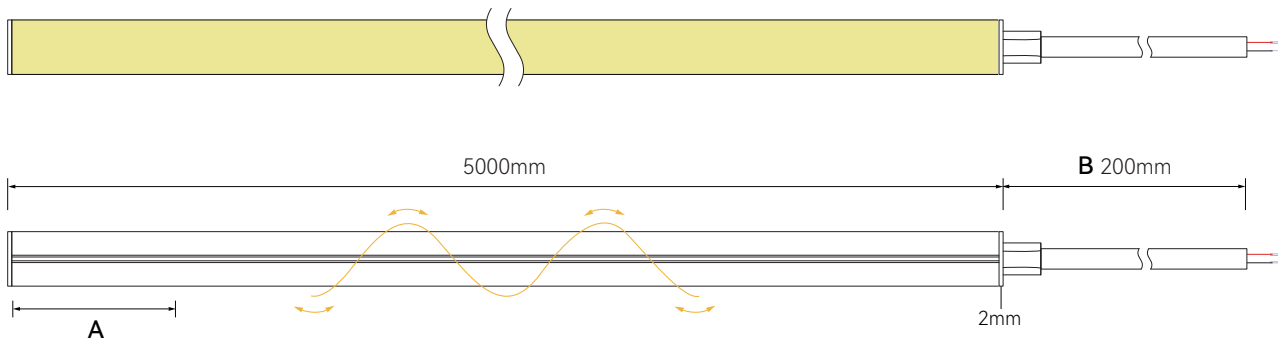

### A) Cutting unit

CCT	Unit
Single-color	50mm

### B) Cable Lead Option

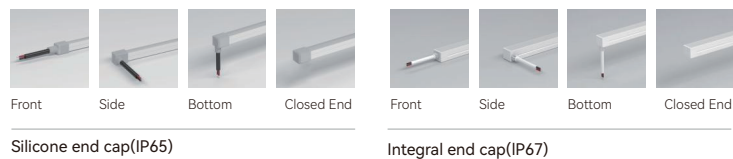

# NCS1010 SIDE BENDING

Flexible Silicone LED Neon Strip



## SPECIFICATION

### SINGLE COLOR - AT2835XX90-24160050-NCS1010

LED type	2835	CRI	CCT	Lumen/m	Efficiency/W
LED Qty's	160LEDs/m	> 90	● 2700K	720	72
PCB width	5mm	> 90	● 3000K	750	75
Voltage	24V	> 90	● 3500K	760	76
Power	10W/m	> 90	● 4000K	850	80
Beam angle	120°	> 90	● 5000K	780	78
Warranty	3-5Years	> 90	● 6000K	800	85

\*Ta=30 °C, 12hours/Day

+/- 10% lumen tolerance

# NCS1010 SIDE BENDING

Flexible Silicone LED Neon Strip



## CUTTING MARK



Use professional scissors to cut vertically at the cutting mark.

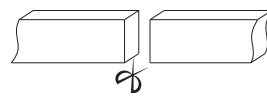
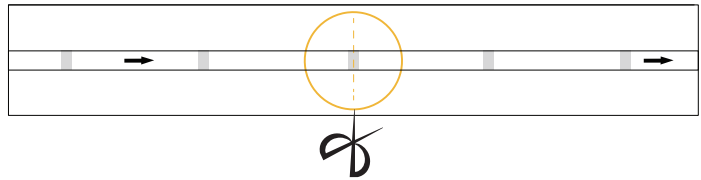

✓ Vertical cutting precisely in the exact cutting position of led strip.

The bottom of the led strip has a clear mark, the black marker is the cutting position.

## ACCESSORIES

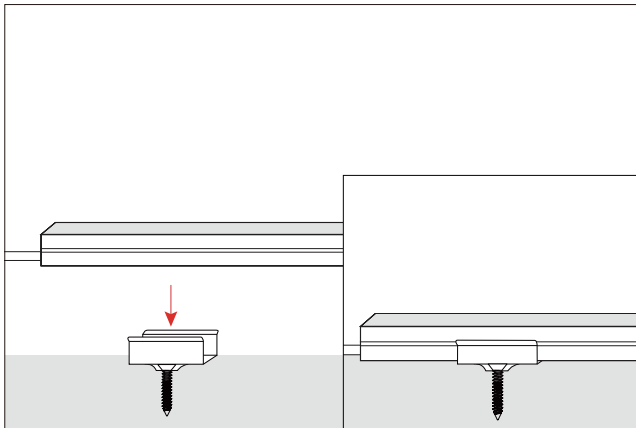

ALUMINIUM MOUNTING CLIPS / ALUMINIUM PROFILE  
W12.4 × H13MM / W12.4 × H13 × 1000MM

END VIEW

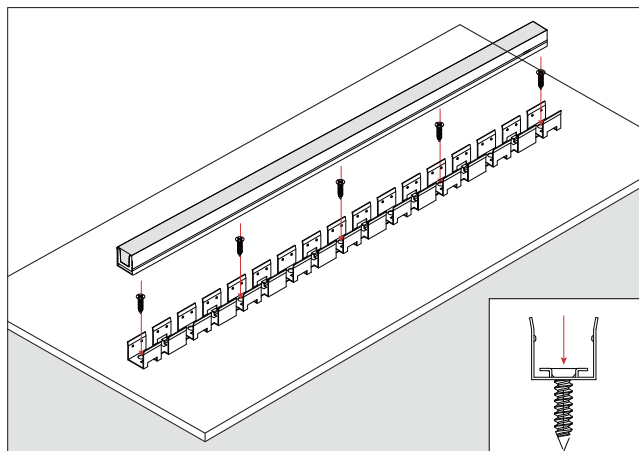
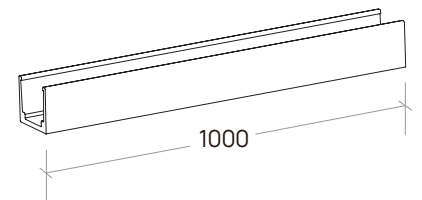
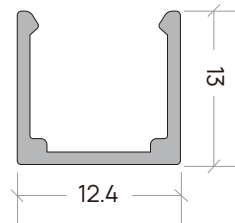

FLEXIBLE STAINLESS STEEL PROFILE  
W15.5 × H14.5MM

END VIEW

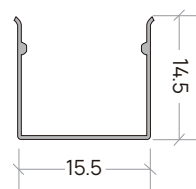

SIDE



TOP



# NCS1010 SIDE BENDING

Flexible Silicone LED Neon Strip



## INSTALLATION PRECAUTIONS-SIDE MOUNTED

If the length of the light is more than 5 meters, two persons must work together to install it.

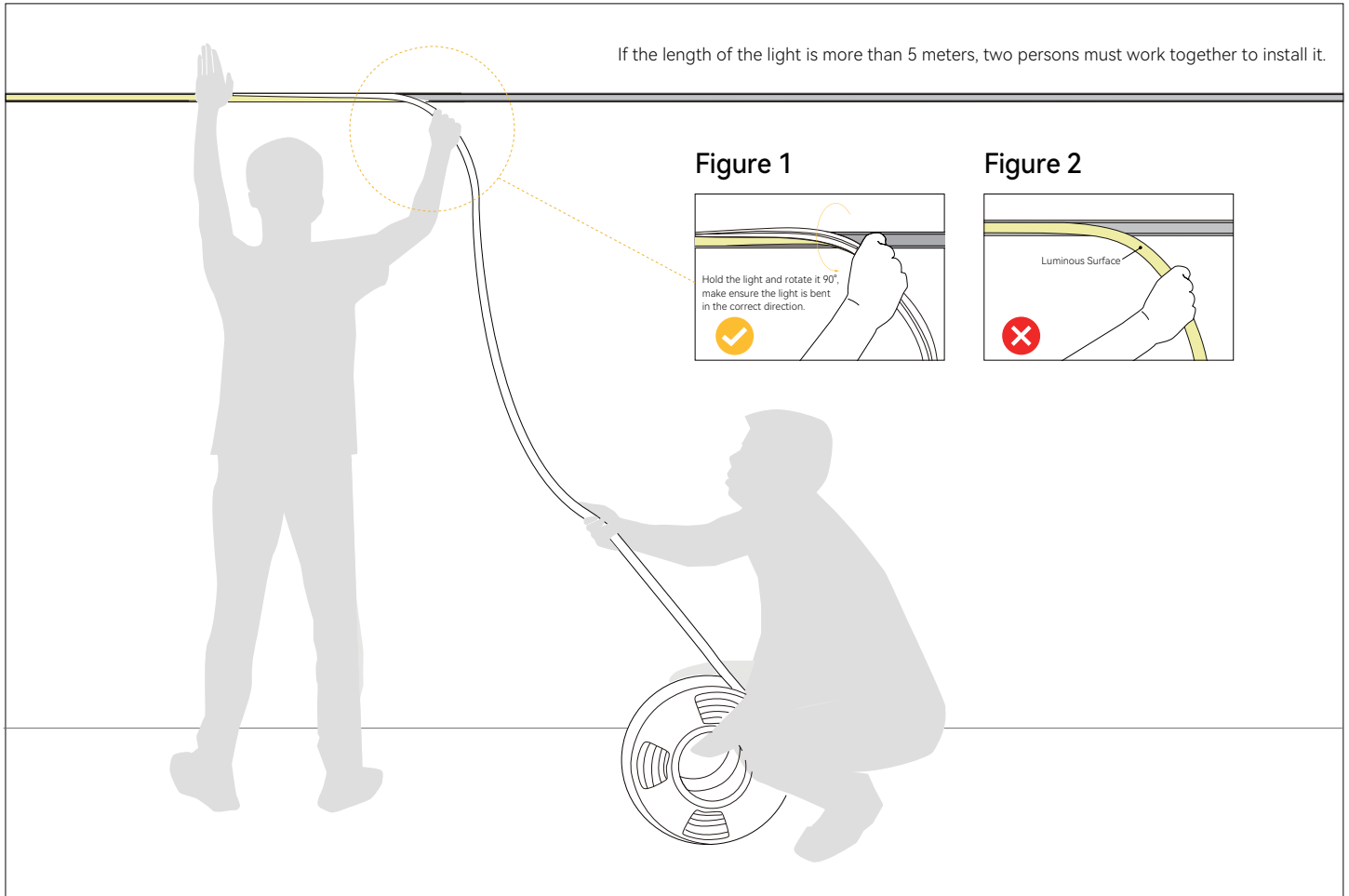

Figure 1

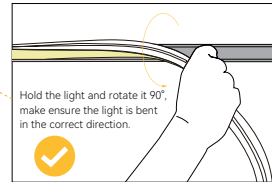
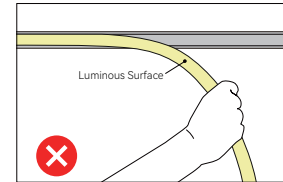

Figure 2



### 1.Installer:

Press the light with the palm of the left hand to slowly load it into the slot. Straighten the light with right hand so that it droop in the direction of your hand. See Figure 1.

Side surface may not be bent or droop See Figure 2.

### 2.Assistant:

Cooperate with the installer to slowly deliver the light to installer. Do not pull or twist the light during the installation.

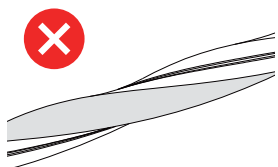

As shown in the figure, twisting or coiling the light strip during installation is prohibited.

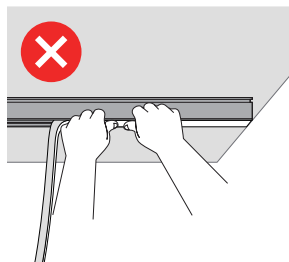

Do not let any portion of the fixture hang in any direction during installation. Use two people to install to ensure the fixture does not hang.

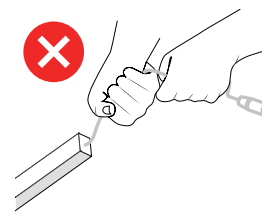
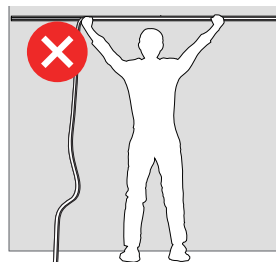

Do not grab or pull by the wire feeds.

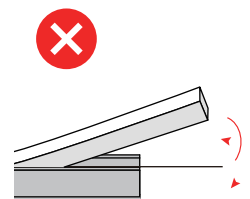

Do not bend the fixture more than 15 degrees when installing into mounting brackets or channels.

# NCS1010 SIDE BENDING

Flexible Silicone LED Neon Strip



## SINGLE COLOR CONNECTION DIAGRAM

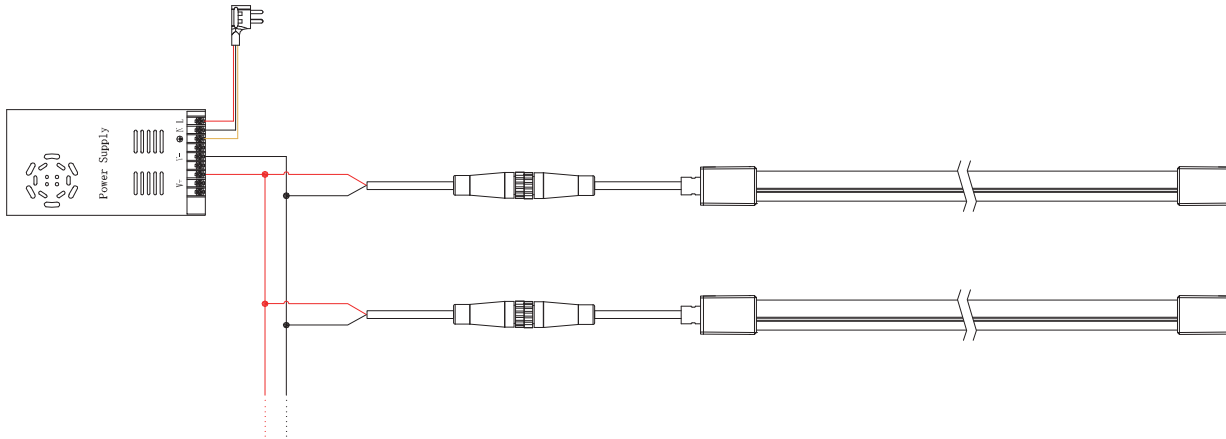

## WARNING

### Power Supply

The product must be powered by an isolated constant-voltage power supply with output ripple  $\leq 5\%$ . A minimum 20% power margin is required (maximum 80% rated load). Non-compliant power supplies will cause unstable operation and premature product failure.

### Voltage & Polarity

Supply voltage and polarity must strictly match product specifications. Incorrect voltage or reverse polarity will cause immediate and irreversible damage.

### Mechanical Bending

Installation must maintain a minimum bending radius of  $\geq 300$  mm. Twisting, sharp bending, or over-bending will permanently damage internal structures.

### Maximum Run Length

The specified maximum continuous run length must not be exceeded. Exceeding this limit will result in overheating, uneven brightness, and shortened service life.